

## JAL-KJ9-OV5670 V1.0

### 5MP OmniVision OV5670 MIPI-Schnittstelle Fester Fokus Kameramodul



Vorderansicht



Rückansicht

#### Spezifikationen

<b>Kameramodul Nr.</b>	<b>JAL-KJ9-OV5670 V1.0</b>
<b>Auflösung</b>	5MP
<b>Bildsensor</b>	OV5670
<b>Sensorart</b>	1/5"
<b>Pixel Größe</b>	1.12 um x 1.12 um
<b>EFL</b>	2.32 mm
<b>F.NO</b>	2.20
<b>Pixel</b>	2592 x 1944
<b>Betrachtungswinkel</b>	76.1°(DFOV) 63.9°(HFOV) 49.8°(VFOV)
<b>Linsenabmessungen</b>	6.50 x 6.50 x 3.90 mm
<b>Modulgröße</b>	19.00 x 6.50 mm
<b>Modultyp</b>	Fester Fokus
<b>Schnittstelle</b>	MIPI
<b>Autofokus-VCM-Treiber-IC</b>	Keiner
<b>Linsenmodell</b>	KLT-LENS-SPY853B-2
<b>Linsentyp</b>	650 nm IR-Schnitt
<b>Betriebstemperatur</b>	-30°C to +85°C
<b>Gegenstecker</b>	DF37NB-20DS-0.4V

**JAL-KJ9-OV5670 V1.0****5MP OmniVision OV5670 MIPI-Schnittstelle Fester Fokus Kameramodul**

Ansicht von oben



Seitenansicht



Untersicht

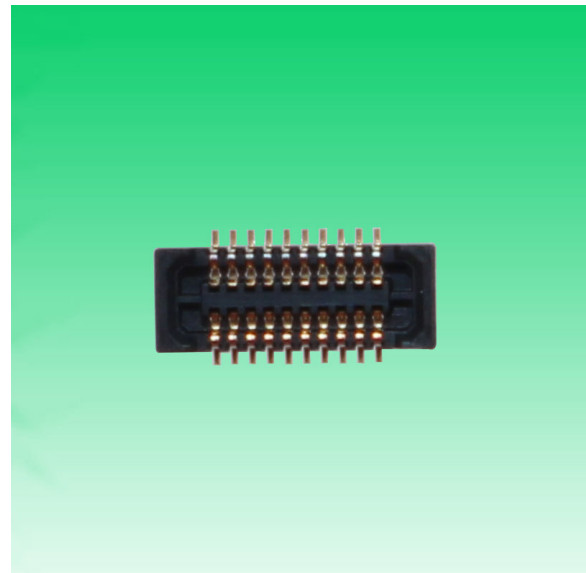

Gegenstecker

CONNECTOR  
20PIN DESCRIPTION

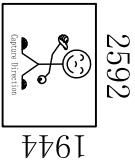

PIN	SIGNAL
1	DGND
2	AVDD2.8
3	VDDI1.8
4	DVDD1.2
5	PW/DN
6	RESET
7	SID_D
8	SID_C
9	FSIN/VSYNC
10	XCLK
11	DGND
12	MCN
13	MCP
14	DGND
15	MDN0
16	MDP0
17	DGND
18	MDN1
19	MDP1
20	DGND

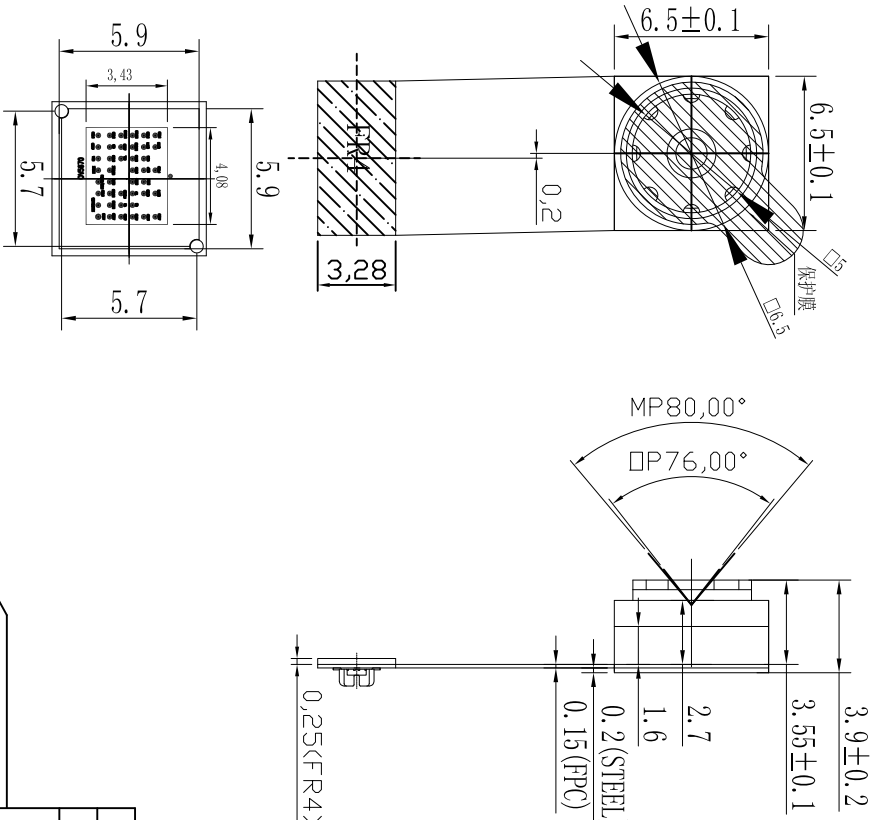

Version	Information	Date
V1.0	First Version	2014-10-22

REV.	Zone	Description	Approved	Date
1/0	All	First Release	Peter	2014-10-22

**Kai Lap Technologies Group Ltd**

Designed By:	ztpeng	Client Name:	
Checked By:	2014-10-22	Model Name:	JAL-KJ9-DV5670 V1.0
Approved By:		Projection Type:	Third Angle
		Unit:	mm
		Scale:	1:1
		Sheet:	1 of 1
		Version:	1/0

SELECT	✓			
Level	A	B	C	D
dim	±0.03	±0.05	±0.08	±0.10
~ 5	±0.05	±0.08	±0.10	±0.15
5~10	±0.08	±0.10	±0.15	±0.20
10~50	±0.10	±0.15	±0.20	±0.25
50~100	±0.10	±0.15	±0.20	±0.25
100~	±0.10%	±0.15%	±0.20%	±0.30%

Parameter	Value
EFL	2.32
BFL	0.75
F/N0	2.2
View Angle	76.1°
Lens Type	1/5 inch
Distortion	<1.5%
Image Sensor	5670
Resolution	20pin



# 0.4 mm Pitch, 0.98 mm Mated Height, Board-to-Board / Board-to-FPC Connectors

## DF37 Series

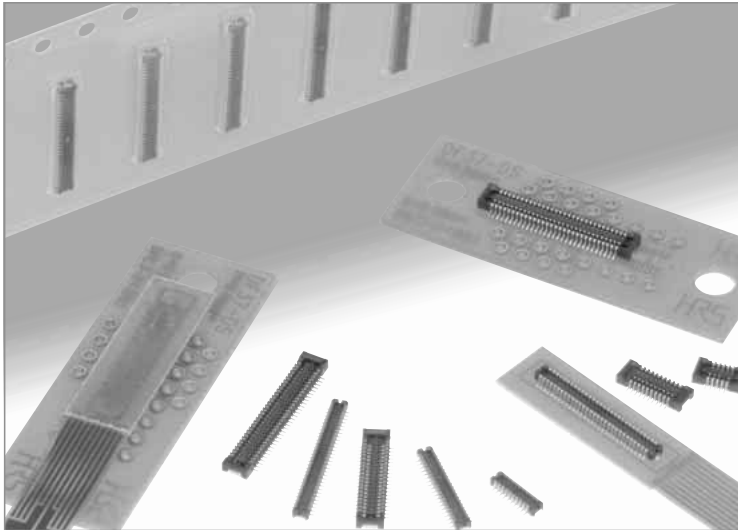

### Further reduction of the board space.

#### Comparison of board mounting space

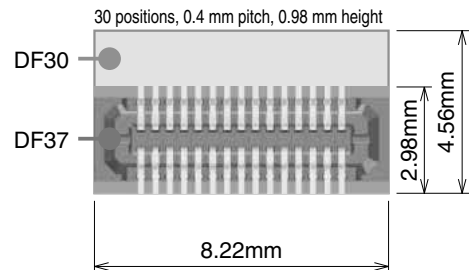

### Features

#### 1. Reduced size and board-occupied area

With the mated height of 0.98 mm, width of 2.98mm and length of 8.22 mm (30 positions) the connectors are one of the smallest in its class. Also 2.6mm depth short-lead type is available.

Sufficiently large flat areas allow pick-up with vacuum nozzles of automatic placement equipment.

#### 2. Reliable electrical and mechanical connection

Despite its small mated height, unique contact configuration, with a 2-point contacts and effective mating length of 0.25mm, assures highly reliable connection while confirming a complete mating with a definite tactile feel.

#### 3. Self alignment

Recognizing the difficulties of mating extremely small connectors in limited spaces, the connectors will self-align within 0.3mm.

#### 4. Physical shock and vibration protection

2-point contact assures electrical connection in a shock or vibration applications.

#### 5. Solder wicking prevention

Nickel barriers (receptacles) and unique forming of the contacts (headers) prevent un-intentional solder wicking.

#### 6. Contamination protection

Insulator walls protect the contact areas against flux splatter or other physical particles contamination.

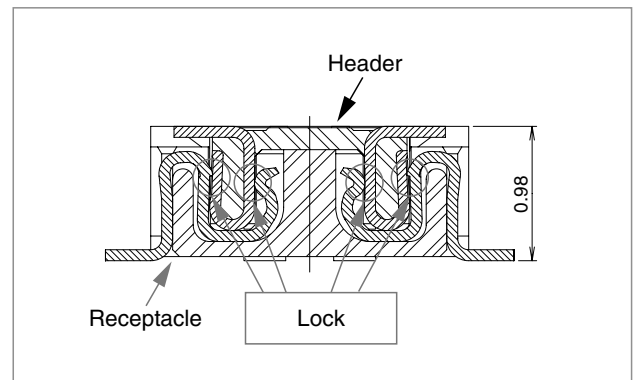

#### Splatter protection

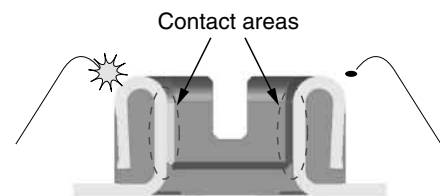

Contact areas are not exposed to the outside penetration of the flux or other physical particles.

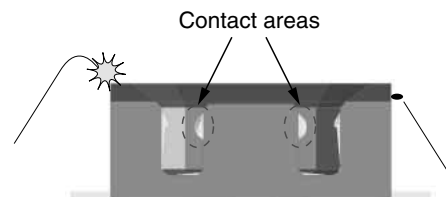

## ■ Specifications

Ratings	Current rating	0.3 A	Operating temperature range	-35°C to +85°C (Note 1)	Storage temperature range	-10°C to +60°C (Note 2)
	Voltage rating	30 V AC, DC	Operating humidity range	RH 20% to 80%	Storage humidity range	RH 40% to 70% (Note 2)

Item	Specification	Conditions
1. Insulation resistance	50 MΩ min	100 V DC
2. Withstanding voltage	No flashover or insulation breakdown	100 V AC / 1 minute
3. Contact resistance	100 mΩ max.	20 mV AC, 1 kHz, 1 mA
4. Vibration	No electrical discontinuity of 1 μs or longer No damage or parts dislocation	Frequency: 10 to 55 Hz, single amplitude of 0.75 mm, 2 hours, 3 axis
5. Humidity	Contact resistance: 100 mΩ max., Insulation resistance: 25 MΩ min.	96 hours at 40 ±2°C and humidity of 90 to 95% No damage or parts dislocation
6. Temperature cycle	Contact resistance: 100 mΩ max., Insulation resistance: 50 MΩ min. No damage or parts dislocation	-55°C → 5 to 35°C → 85°C → 5 to 35°C Time: 30 min. → 10 min. → 30 min. → 10 min. 5 cycles
7. Durability	Contact resistance: 100 mΩ max.	10 cycles
8. Resistance to soldering heat	No deformation of components affecting performance	Reflow: At the recommended temperature profile Manual soldering: 350°C for 3 seconds

Note 1: Includes temperature rise caused by current flow.

Note 2: The term "storage" here refers to products stored for a long period prior to board mounting and use.

The operating temperature and humidity range covers the non-conducting condition of connectors after board mounting and the temporary storage conditions of transportation, etc.

## ■ Materials

### Receptacle

Part	Material	Finish	Remarks
Insulator	LCP	Color: Black	UL94V-0

### Header

Part	Material	Finish	Remarks
Contacts	Phosphor bronze	Gold plated	_____

## ■ Ordering Information

### ● Receptacles

**DF 37 # - \* DS - 0.4 V (\*\*)**

①      ②      ③      ④      ⑤      ⑥      ⑦

① Series name : DF37	④ Connector style DS: Receptacle
② Configuration NB: With metal fittings NC: Without metal fittings SB: Short-lead type with metal fittings	⑤ Contact pitch : 0.4 mm
③ Number of contacts NB/NC : 10, 16, 20, 24, 30, 34, 40, 50, 60, 70, 74 SB : 10, 16, 20, 24, 30, 34, 40, 50, 60	⑥ Terminal type V: SMT vertical mount
	⑦ Packaging (51): Embossed tape packaging (8,000 pieces per reel) (53): Embossed tape packaging (1,000 pieces per reel)

### ● Headers

**DF 37 # - \* DP - 0.4 V (\*\*)**

①      ②      ③      ④      ⑤      ⑥      ⑦

① Series name : DF37	④ Connector style DP: Header
② Configuration B: With metal fittings C: Without metal fittings	⑤ Contact pitch : 0.4 mm
③ Number of contacts 10, 16, 20, 24, 30, 34, 40, 50, 60, 70, 74	⑥ Terminal type V: SMT vertical mount
	⑦ Packaging (51): Embossed tape packaging (8,000 pieces per reel) (53): Embossed tape packaging (1,000 pieces per reel)

Note : The short-lead type is only available for the receptacle side (with hardware).

## ■ Receptacles (DF37NB/NC)

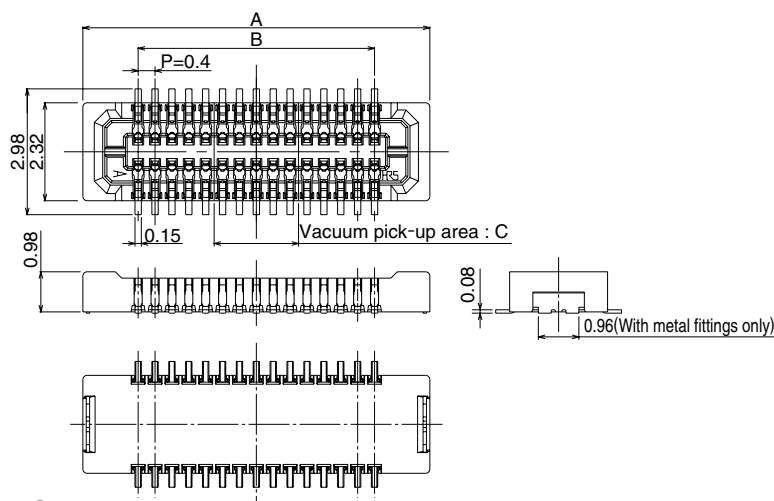
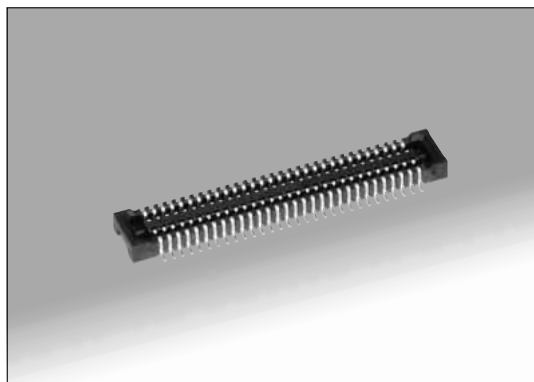

## ■ Recommended metal mask dimensions

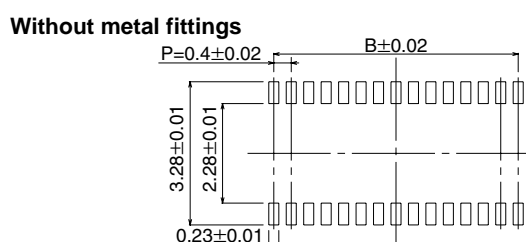
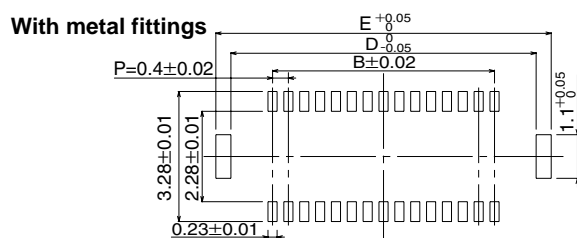

## ■ Recommended PCB mounting pattern

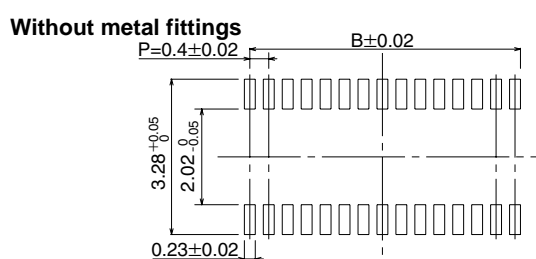
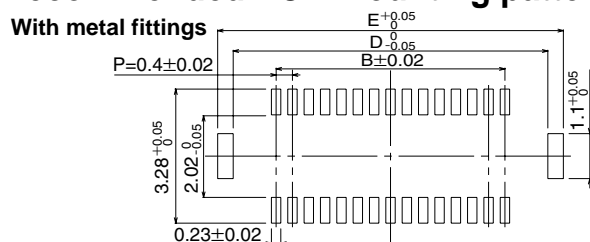

### ● With metal fittings

All dimensions: mm

Part Number	CL No.	Number of Contacts	A	B	C	D	E
DF37NB-10DS-0.4V(51)	CL684-3301-6-51	10	4.22	1.6	0.8	3.7	4.46
DF37NB-16DS-0.4V(51)	CL684-3302-9-51	16	5.42	2.8	1.2	4.9	5.66
DF37NB-20DS-0.4V(51)	CL684-3303-1-51	20	6.22	3.6	1.6	5.7	6.46
DF37NB-24DS-0.4V(51)	CL684-3304-4-51	24	7.02	4.4	2	6.5	7.26
DF37NB-30DS-0.4V(51)	CL684-3305-7-51	30	8.22	5.6	2	7.7	8.46
DF37NB-34DS-0.4V(51)	CL684-3082-4-51	34	9.02	6.4	2.4	8.5	9.26
DF37NB-40DS-0.4V(51)	CL684-3306-0-51	40	10.22	7.6	2.4	9.7	10.46
DF37NB-50DS-0.4V(51)	CL684-3307-2-51	50	12.22	9.6	2.8	11.7	12.46
DF37NB-60DS-0.4V(51)	CL684-3308-5-51	60	14.22	11.6	3.2	13.7	14.46
DF37NB-70DS-0.4V(51)	CL684-3409-2-51	70	16.22	13.6	3.6	15.7	16.46
DF37NB-74DS-0.4V(51)	CL684-3080-9-51	74	17.02	14.4	4	16.5	17.26

### ● Without metal fittings

All dimensions: mm

Part Number	CL No.	Number of Contacts	A	B	C
DF37NC-10DS-0.4V(51)	CL684-3309-8-51	10	4.22	1.6	0.8
DF37NC-16DS-0.4V(51)	CL684-3310-7-51	16	5.42	2.8	1.2
DF37NC-20DS-0.4V(51)	CL684-3311-0-51	20	6.22	3.6	1.6
DF37NC-24DS-0.4V(51)	CL684-3312-2-51	24	7.02	4.4	2
DF37NC-30DS-0.4V(51)	CL684-3313-5-51	30	8.22	5.6	2
DF37NC-34DS-0.4V(51)	CL684-3083-7-51	34	9.02	6.4	2.4
DF37NC-40DS-0.4V(51)	CL684-3314-8-51	40	10.22	7.6	2.4
DF37NC-50DS-0.4V(51)	CL684-3315-0-51	50	12.22	9.6	2.8
DF37NC-60DS-0.4V(51)	CL684-3316-3-51	60	14.22	11.6	3.2
DF37NC-70DS-0.4V(51)	CL684-3084-0-51	70	16.22	13.6	3.6
DF37NC-74DS-0.4V(51)	CL684-3081-1-51	74	17.02	14.4	4

Note 1: Tape and reel packaging (8,000 pieces/reel). Order by number of reels.  
 Note 2: This connector is NOT polarized.

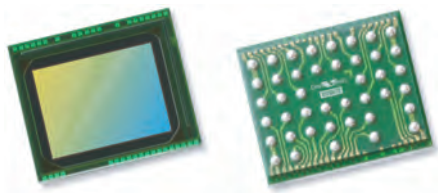

# OV5670 5-megapixel product brief



## 5-Megapixel PureCel® Image Sensor Brings Improved Image Quality to Rear- and Front-Facing Cameras in Mobile Devices



available in a lead-free package

The OV5670 is a 5-megapixel PureCel image sensor that leverages a 1.12-micron pixel to deliver exceptional still images and high-definition (HD) video to front- and rear-facing cameras in smartphones and tablets.

The OV5670 PureCel image sensor can capture full resolution 5-megapixel (2592x1944) images at 30 frames per second (fps), quad HD video at 30 fps, cropped 1080p HD at 60 fps, or 720p HD at 60 fps. When recording 720p HD video with binning, the sensor achieves sensitivity and signal-to-noise ratio that is comparable to the industry's popular 1.75-micron pixel. Additionally, the sensor's 1.12-micron pixel achieves similar full-well capacity (FWC) as the previous generation's 1.4-micron pixel.

When recording full resolution video, the OV5670 uses approximately 35 percent less power compared to OmniVision's previous generation 5-megapixel sensor. The sensor's ultra low power mode further reduces power consumption, thus minimizing battery drain.

The OV5670 fits into a compact 6 x 6 x 3.5 mm camera module, and is available in a cost-effective chip scale package (CSP).

Find out more at [www.ovt.com](http://www.ovt.com).



## Applications

- Smartphones and Feature Phones
- Tablets
- PC Multimedia
- Wearables

## Product Features

- 1.12  $\mu\text{m}$  x 1.12  $\mu\text{m}$  pixel
- 5MP at 30 fps
- programmable controls for frame rate, mirror and flip, cropping, and windowing
- supports images sizes:
  - 5MP (2592x1944)
  - Quad HD (2560x1440)
  - 1080p (1920x1080)
  - 720p (1280x720)
  - VGA (640x480), and more
- 2k bits of embedded one-time programmable (OTP) memory for customer use
- ultra low power mode (ULPM)
- support for output formats: 10-bit RGB RAW
- interleave row HDR output
- two-wire serial bus control (SCCB)
- MIPI serial output interface (1- or 2-lane)
- 2x binning support
- image quality control:
  - defect pixel correction
  - automatic black level calibration

# OV5670

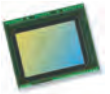

## Ordering Information

- OV05670-G04A**  
(color, chip probing, 200  $\mu\text{m}$  backgrinding, reconstructed wafer)
- OV05670-H42A**  
(color, lead-free, 42-pin CSP5)

## Product Specifications

- active array size:** 2592 x 1944
- input clock frequency:** 6 - 27 MHz
- power supply:**
  - core: 1.14 - 1.26V (1.2V nominal)
  - analog: 2.6 - 3.0V (2.8V nominal)
  - I/O: 1.7 - 1.9V (1.8V nominal)
- max S/N ratio:** 35.6 dB
- dynamic range:** 68.4 dB @ 16x gain
- power requirements:**
  - active: 126 mW
  - standby: 166  $\mu\text{W}$
  - XSHUTDOWN: 1  $\mu\text{W}$
- temperature range:**
  - operating: -30°C to +85°C junction temperature
  - stable image: -20°C to +60°C junction temperature
- maximum image transfer rate:**
  - 5MP (2592x1944): 30 fps
  - Quad HD (2560x1440): 30 fps
  - 1080p (1920x1080): 60 fps
  - 720p (1280x720): 60 fps
  - VGA (640x480): 120 fps
- sensitivity:** 490 mV/lux-sec
- pixel size:** 1.12  $\mu\text{m}$  x 1.12  $\mu\text{m}$
- output interfaces:** 2-lane MIPI serial output
- dark current:** 14 e<sup>-</sup>/sec @ 60°C junction temperature
- output formats:** 10-bit RAW RGB data
- image area:** 2945.7  $\mu\text{m}$  x 2214  $\mu\text{m}$
- lens size:** 1/5"
- package/die dimensions:**
  - CSP5: 4080  $\mu\text{m}$  x 3430.2  $\mu\text{m}$
  - COB: 4050  $\mu\text{m}$  x 3400.2  $\mu\text{m}$
  - RW: 4100  $\mu\text{m}$  x 3450.2  $\mu\text{m}$
- lens chief ray angle:** 31.24° non-linear

## Functional Block Diagram

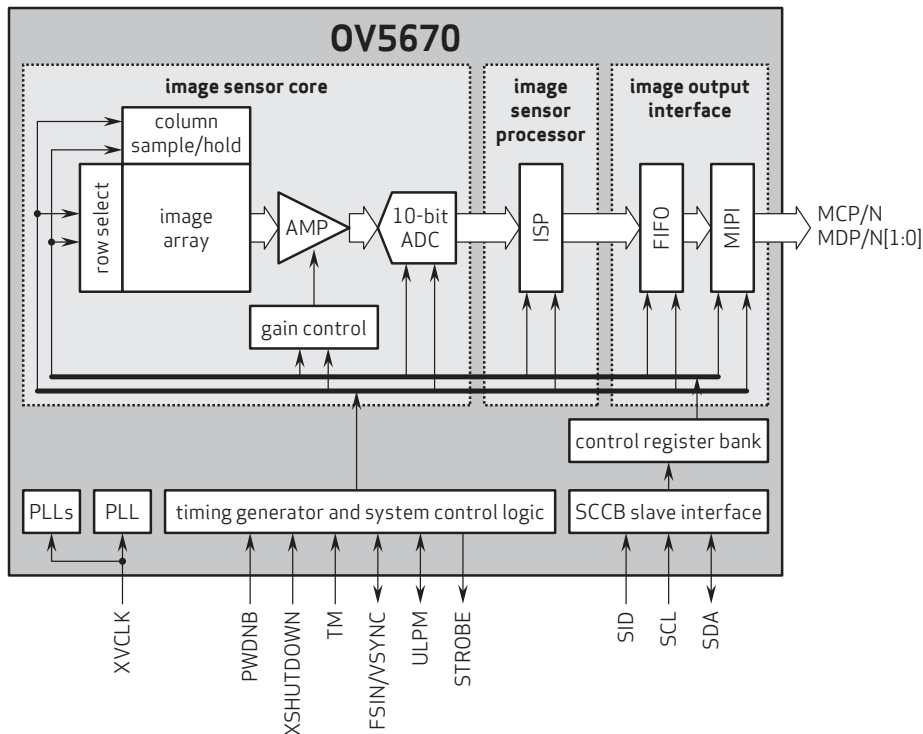

4275 Burton Drive  
Santa Clara, CA 95054  
USA

Tel: + 1 408 567 3000  
Fax: + 1 408 567 3001  
www.ovt.com

OmniVision reserves the right to make changes to their products or to discontinue any product or service without further notice. OmniVision, the OmniVision logo and PureCel are registered trademarks of OmniVision Technologies, Inc. All other trademarks are the property of their respective owners.



OmniVision



Kameraanwendungen

*your BEST camera module partner*



Autopilot



Live-Streaming



Videokonferenz



Biometrische Eye-Tracker-Erkennung



Maschinelles Sehen



Agrarmonitor



Nachtsichtsicherheit



Drohnen- und Sport-Adleraugen



Interaktive Haustierkamera

[www.KaiLapTech.com](http://www.KaiLapTech.com) [sales@KaiLapTech.com](mailto:sales@KaiLapTech.com) Tel: (852) 6908 1256 Fax: (852) 3017 6778



*your BEST camera module partner*

## Kameraanwendungen



### IMAGING DEVICES





Referenztable für die Pinbelegungsdefinition des Kameramoduls

OmniVision Sony Himax Samsung On-Semi Aptina Himax GalaxyCore PixArt Bildsensoren	
Pin Signal	Beschreibung
DGND GND	Masse für digitale Schaltung
AGND	Masse für analoge Schaltung
PCLK DCK	DVP-PCLK-Ausgang
XCLR PWDN XSHUTDOWN STANDBY	Abschalten aktiv hoch mit internem Pulldown-Widerstand
MCLK XVCLK XCLK INCK	Systemeingangsuhr
RESET RST	Aktiv Low mit internem Pull-up-Widerstand zurücksetzen
NC NULL	keine Verbindung
SDA SIO_D SIOD	SCCB-Daten
SCL SIO_C SOIC	SCCB-Eingangstakt
VSYNC XVS FSYNC	DVP-VSYNC-Ausgang
HREF XHS	DVP-HREF-Ausgang
DOVDD	Strom für E/A-Schaltung
AFVDD	Strom für VCM-Schaltung
AVDD	Strom für analoge Schaltung
DVDD	Strom für digitale Schaltung
STROBE FSTROBE	Strobe-Ausgang
FSIN	Synchronisieren Sie das VSYNC-Signal vom anderen Sensor
SID	SCCB letzte Bit-ID-Eingabe
ILPWM	mechanische Shutter-Ausgangsanzeige
FREX	Rahmenbelichtung / mechanischer Verschluss
GPIO	Allzweckeingänge
SLASEL	I2C-Slave-Adresse auswählen
AFEN	CEN-Chip aktivieren aktiv hoch auf VCM-Treiber-IC
<b>MIPI Schnittstelle</b>	
MDN0 DN0 MD0N DATA_N DMO1N	MIPI 1st negative Ausgabe der Datenspur
MDP0 DP0 MD0P DATA_P DMO1P	MIPI 1st positiver Ausgang der Datenspur
MDN1 DN1 MD1N DATA2_N DMO2N	MIPI 2nd negative Ausgabe der Datenspur
MDP1 DP1 MD1P DATA2_P DMO2P	MIPI 2nd positiver Ausgang der Datenspur
MDN2 DN2 MD2N DATA3_N DMO3N	MIPI 3rd negative Ausgabe der Datenspur
MDP2 DP2 MD2P DATA3_P DMO3P	MIPI 3rd positiver Ausgang der Datenspur
MDN3 DN3 MD3N DATA4_N DMO4N	MIPI 4th negative Ausgabe der Datenspur
MDP3 DP3 MD3P DATA4_P DMO4P	MIPI 4th positiver Ausgang der Datenspur
MCN CLKN CLK_N DCKN	MIPI Uhr negativer Ausgang
MCP CLKP MCP CLK_P DCKN	MIPI Takt positiver Ausgang
<b>DVP Parallel Schnittstelle</b>	
D0 DO0 Y0	DVP Datenausgabeport 0
D1 DO1 Y1	DVP Datenausgabeport 1
D2 DO2 Y2	DVP Datenausgabeport 2
D3 DO3 Y3	DVP Datenausgabeport 3
D4 DO4 Y4	DVP Datenausgabeport 4
D5 DO5 Y5	DVP Datenausgabeport 5
D6 DO6 Y6	DVP Datenausgabeport 6
D7 DO7 Y7	DVP Datenausgabeport 7
D8 DO8 Y8	DVP Datenausgabeport 8
D9 DO9 Y9	DVP Datenausgabeport 9
D10 DO10 Y10	DVP Datenausgabeport 10
D11 DO11 Y11	DVP Datenausgabeport 11

## Kamera-Zuverlässigkeitstest

Reliability Inspection Item		Testmethode	Akzeptanzkriterium	
Kategorie	Artikel			
Umwelt	Lager Temperatur	Hoch 60°C 96 Std	Temperaturkammer	Keine anormale Situation
		Niedrig -20°C 96 Std	Temperaturkammer	Keine anormale Situation
	Betriebs Temperatur	Hoch 60°C 24 Std	Temperaturkammer	Keine anormale Situation
		Niedrig -20°C 24 Std	Temperaturkammer	Keine anormale Situation
	Feuchtigkeit	60°C 80% 24 Std	Temperaturkammer	Keine anormale Situation
	Thermischer Schock	Hoch 60°C 0.5 Std Niedrig -20°C 0.5 Std Radfahren rein 24 Std	Temperaturkammer	Keine anormale Situation
Physisch	Falltest (Im freien Fall)	Ohne Verpackung 60cm	10 Mal auf Holzboden	Elektrisch funktionsfähig
		Mit Paket 60cm	10 Mal auf Holzboden	Elektrisch funktionsfähig
	Vibrations Test	50Hz X-Axis 2mm 30 Minuten	Vibrationstisch	Elektrisch funktionsfähig
		50Hz Y-Axis 2mm 30 Minuten	Vibrationstisch	Elektrisch funktionsfähig
		50Hz Z-Axis 2mm 30 Minuten	Vibrationstisch	Elektrisch funktionsfähig
	Zugfestigkeit des Kabels Krafttest	Gewicht laden 4 kg 60 Sekunden Radfahren rein 24 Std	Zugprüfmaschine	Elektrisch funktionsfähig
Elektrisch	ESD-Test	Kontaktaufnahme 2 KV	ESD-Prüfmaschine	Elektrisch funktionsfähig
		Luftentladung 4 KV	ESD-Prüfmaschine	Elektrisch funktionsfähig
	Alterungstest	On/Off 30 Sekunden Radfahren rein 24 Std	Stromschalter	Elektrisch funktionsfähig
	USB-Anschluss	On/Off 250 Mal	Einstecken und ausstecken	Elektrisch funktionsfähig





Inspektionsgegenstand		Untersuchungsmethode	Inspektionsstandard	
Kategorie	Artikel			
Aussehen	FPC oder PCB	Farbe	Das bloße Auge	Größere Unterschiede sind nicht zulässig.
		Zerrissen/gehackt werden	Das bloße Auge	Das Freilegen von Kupferrissen ist nicht zulässig.
		Markierung	Das bloße Auge	Klar, erkennbar (innerhalb von 30 cm Entfernung)
	Halterin	Kratzer	Das bloße Auge	Die Freilegung von Rissen im Inneren ist nicht zulässig
		Lücke	Das bloße Auge	Erfüllen Sie den Höhenstandard
		Schraube	Das bloße Auge	Stellen Sie sicher, dass Schrauben vorhanden sind (falls vorhanden)
		Schaden	Das bloße Auge	Die Freilegung von Rissen im Inneren ist nicht zulässig
	Linse	Kratzen	Das bloße Auge	Keine Auswirkung auf den Auflösungsstandard
		Kontamination	Das bloße Auge	Keine Auswirkung auf den Auflösungsstandard
		Ölfilm	Das bloße Auge	Keine Auswirkung auf den Auflösungsstandard
		Abdeckband	Das bloße Auge	Kein Problem beim Aussehen.
	Funktion	Bild	Keine Kommunikation	Testboard
Helles Pixel			Tafel	Im Image Center nicht erlaubt
Dunkles Pixel			Weißer Tafel	Im Image Center nicht erlaubt
Verschwommen			Das bloße Auge	Nicht erlaubt
Kein Bild			Das bloße Auge	Nicht erlaubt
Vertikale Linie			Das bloße Auge	Nicht erlaubt
Horizontale Linie			Das bloße Auge	Nicht erlaubt
Kleines Leck			Das bloße Auge	Nicht erlaubt
Blinkendes Bild			Das bloße Auge	Nicht erlaubt
Prellung			Inspektionslehre	Nicht erlaubt
Auflösung			Diagramm	Folgt dem Diagrammstandard für ausgehende Inspektionen
Farbe			Das bloße Auge	Kein Problem
Lärm			Das bloße Auge	Nicht erlaubt
Ecke dunkel			Das bloße Auge	Weniger als 100 x 100 Pixel
Farbauflösung			Das bloße Auge	Kein Problem
Abmessungen	Höhe	Das bloße Auge	Follows Approval Data Sheet	
	Breite	Das bloße Auge	Follows Approval Data Sheet	
	Länge	Das bloße Auge	Follows Approval Data Sheet	
	Gesamt	Das bloße Auge	Follows Approval Data Sheet	



## KLT-Paketlösungen

KLT Kameramodul



Komplett mit Linsenschutzfolie



Tablett mit Gitter und Raum



Legen Sie die Kameras auf das Tablett



## Paketlösung für Kameramodule

Volles Tablett mit Kameras



Abdeckschale mit Deckel



In Antistatikbeutel stecken



Staubsaugen Sie den antistatischen Beutel





## Paketlösung für Kameramodule

Versiegelter Vakuumbbeutel mit Etiketten

1. Modell und Beschreibung 2. Menge 3. Versanddatum 4. Achtung





## Paketlösung für große Bestellungen

Schaumstoffplatten zwischen  
die Tablettts legen



Schaumstoffplatten sind etwas  
größer als Tablettts



Legen Sie Schaumstoffplatten und  
Tablettts in die Schachtel



Schaumstoffplatten sind eng anliegende Box





## Paketlösung für kleine Bestellungen

Legen Sie die Schaumstoffplatten und  
Tablets in die kleine Schachtel



Schaumstoffplatten passen gut in  
die kleine Box



Paket in kleiner Box für den Versand



Legen Sie kleine Kartons in größere Kartons





## Carbon Box Paketlösung

Verschließen Sie die Carbonbox

Beschriftete Schachtel mit Endverpackung



### Versandfertige Karbonbox

1. Lieferadresse und Telefonnummer
2. Box-Nr. und Versanddatum
3. Zerbrechliche Vorsicht



## Lösung für Musterbestellungspakete

Legen Sie die Probe in einen kleinen antistatischen Beutel



Stecken Sie die Anschlüsse in den kleinen antistatischen Beutel



### Musteretiketten auf dem kleinen Beutel

1. Kameramodul oder Anschlussmodell 2. Lieferdatum und Menge 3. Achtung





## Connectors Large Order Package Solution

Steckverbinder in einem Rad



Steckverbinder im Rad beschriften



Das Rad passt perfekt in die Box



Steckerbox versandfertig



**Unternehmen Kai Lap Technologies (KLT)**

Kai Lap Technologies Group Limited. (KLT) wurde 2009 gegründet und ist ein technologiegetriebener Hersteller der nächsten Generation, der sich auf Forschung, Design und Produktion von Audio- und Videoprodukten spezialisiert hat. KLT verfügt über 20.000 Quadratfuß automatisierte Fabriken mit 100 Mitarbeitern und einem jährlichen Durchsatz von 30.000.000 Kameraeinheiten.

KLT bietet OEM-, ODM-Design, Auftragsfertigung und baut die Kameraprodukte. Sie können uns die Anforderungen auch mit einem Handentwurf übermitteln, unser Vertrieb und unsere Technik arbeiten zusammen, um Ihre Anforderungen zu erfüllen. Wir verstehen uns als Ihr langfristiger Partner bei der Entwicklung praktischer und innovativer Lösungen.

Unser Team deckt alles von der ersten Konzeptentwicklung bis zum Massenprodukt ab. KLT ist spezialisiert auf kundenspezifisches Kameradesign, Rohmaterial, Elektrotechnik, Firmware-/Softwareentwicklung, Produkttests und Verpackungsdesign. Unsere erfahrenen strategischen Versorgungssysteme bieten eine robuste und zuverlässige Fertigungskapazität für Aufträge unterschiedlicher Größe.

**Eingeschränkte Garantie**

KLT gewährt die folgende eingeschränkte Garantie, wenn Sie das/die Produkt(e) direkt von der Firma KLT oder von der Website von KLT, [www.KaiLapTech.com](http://www.KaiLapTech.com), gekauft haben. Produkte, die von anderen Verkäufern oder Quellen gekauft wurden, fallen nicht unter diese beschränkte Garantie. KLT garantiert, dass das/die Produkt(e) bei normalem Gebrauch für einen Zeitraum von einem (1) Jahr ab dem Datum, an dem Sie das Produkt erhalten („Garanzzeitraum“), frei von Material- und Verarbeitungsfehlern sind.

Für alle Produkte, die während des Garanzzeitraums Material- oder Verarbeitungsfehler enthalten oder entwickeln, wird KLT nach eigenem Ermessen entweder: (i) die Produkte reparieren; (ii) das/die Produkt(e) durch ein neues oder generalüberholtes Produkt(e) ersetzen (Ersatzprodukt(e) sind von identischem Modell oder funktionell gleichwertig); oder (iii) Ihnen den Preis erstatten, den Sie für das/die Produkt(e) gezahlt haben.

Diese eingeschränkte Garantie von KLT ist ausschließlich auf Reparatur und/oder Ersatz zu den oben genannten Bedingungen beschränkt. KLT ist nicht zuverlässig oder verantwortlich für nachfolgende Ereignisse.





# CMOS CAMERA MODULES



*your BEST camera module partner*

## KLT Stärke

Leistungsstarke Fabrik



## Professioneller Service



## Versprochene Lieferung



[www.KaiLapTech.com](http://www.KaiLapTech.com) [sales@KaiLapTech.com](mailto:sales@KaiLapTech.com) Tel: (852) 6908 1256 Fax: (852) 3017 6778

All rights reserved @ Kai Lap Technologies Group Ltd. Specifications subject to change without notice.